

GENERAL FEATURES

- Able to operate at 60°C
- Integrated design to ensure the best uniformity and reliability
- Longer Service Life and high stability under high temp. (no air-con needed)
- Use special additives:
Deep discharge recovery capability

APPLICATIONS

- BTS Stations
- Solar & Wind energy system
- UPS system
- Telecom systems
- Power Plants
- Cable TV Systems



DIMENSIONS & WEIGHT

Length(mm)	171±1
Width(mm)	72±1
Height(mm)	205±1
Total Height(mm)	222±1
Weight(kg)	6.4±3%

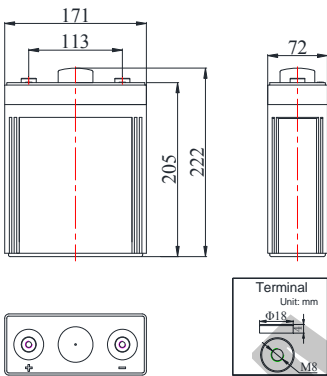

COMPLIED STANDARDS

IEC 60896-21/22	JIS C8704
YD/T1360	BS6290 part4
GB/T 19638	UL 1989

TECHNICAL SPECIFICATIONS



Nominal Voltage		2V(1 cells per unit)
Design Floating Life @25°C		15 Years
Nominal Capacity @25°C (10 hour rate@12.0A,1.8V)		120Ah
Capacity @25°C	20 hour rate (6.36A,1.80V)	127.2Ah
	5 hour rate (21.1A,1.75V)	105.5Ah
	1 hour rate (76.9A,1.60V)	76.9Ah
Internal Resistance	Full Charged Battery@25°C	≤1.6mΩ
Ambient Temperature	Discharge	-30°C~60°C
	Charge	-30°C~60°C
	Storage	-30°C~60°C
Max.Discharge Current@25°C		600A(5s)
Capacity affected by Temperature (10 hr Capacity)	40°C	108%
	25°C	100%
	0°C	90%
	-15°C	70%
Self-Discharge@25°C per Month		3%

Charge (Constant Voltage) @25°C	Standby Use	Initial Charging Current Less than 18A Voltage 2.23-2.27V
	Cycle Use	Initial Charging Current Less than 18A Voltage 2.33-2.37V

BATTERY DISCHARGE TABEL

Discharge Constant Current per Cell (Amperes at 25°C)

F.V/Time	30min	45min	1h	2h	3h	4h	5h	6h	8h	10h	20h
1.60V	127.6	96.6	76.9	45.0	34.3	26.6	22.3	19.4	15.6	12.6	6.66
1.65V	120.8	92.9	74.4	43.6	33.2	26.0	22.0	19.1	15.5	12.4	6.60
1.70V	117.4	89.5	72.4	42.4	32.4	25.4	21.5	18.7	15.2	12.2	6.53
1.75V	112.2	85.6	69.7	41.3	31.7	24.8	21.1	18.4	15.1	12.1	6.47
1.80V	108.1	82.4	67.3	39.7	30.7	24.2	20.6	18.0	14.6	12.0	6.36

Discharge Constant Power per Cell (Watts at 25°C)

F.V/Time	30min	45min	1h	2h	3h	4h	5h	6h	8h	10h	20h
1.60V	246.1	183.5	148.1	85.3	65.6	51.1	43.1	37.6	30.7	24.6	13.1
1.65V	235.1	177.2	144.1	83.0	64.0	50.2	42.4	37.0	30.5	24.4	12.8
1.70V	225.1	171.6	139.2	81.1	62.5	49.2	41.8	36.5	30.0	24.1	12.7
1.75V	214.0	164.8	134.2	79.2	61.3	48.1	41.2	35.9	29.3	23.9	12.6
1.80V	205.0	159.2	129.8	76.6	59.6	47.0	40.3	35.3	28.7	23.8	12.5

Note The above data are average values, and can be obtained within 3 charge/discharge cycles. These are not minimum values. Cell and battery designs/specifications are subject to modification without notice. Contact MCA for the latest information.

PERFORMANCE CHARACTERISTICS

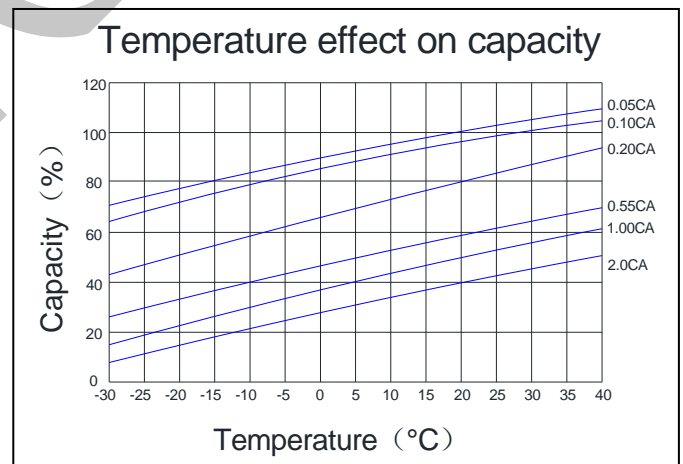
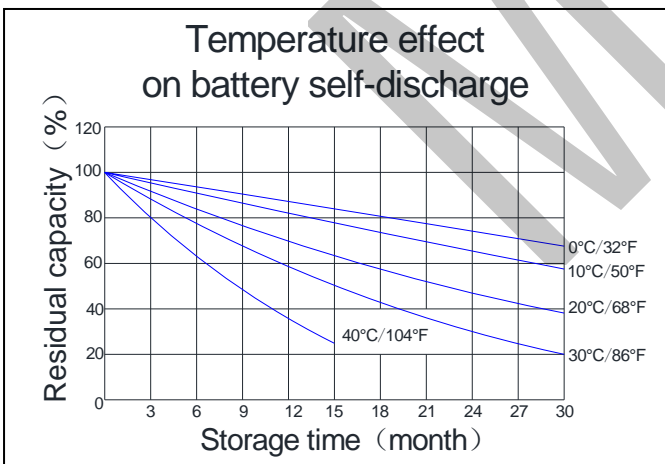
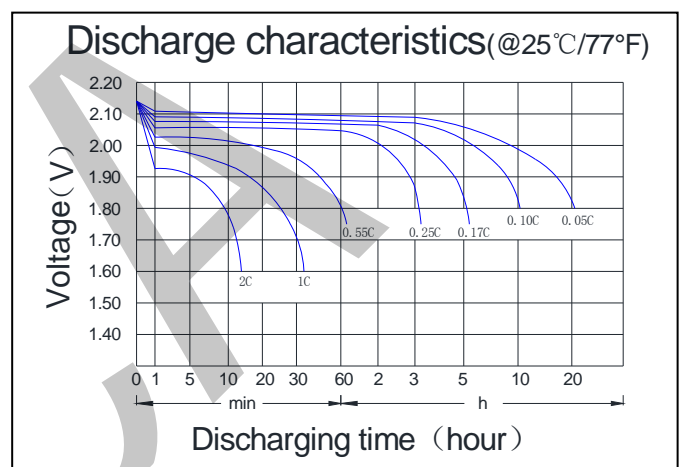
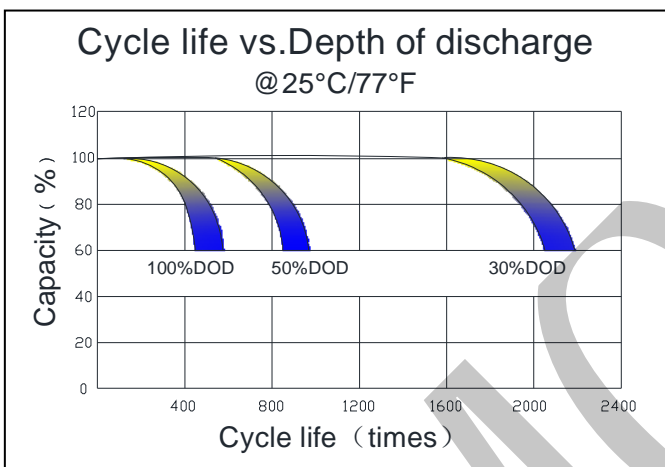
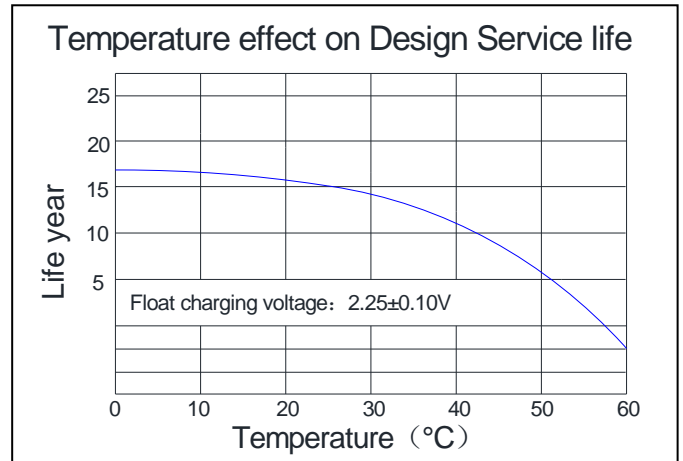
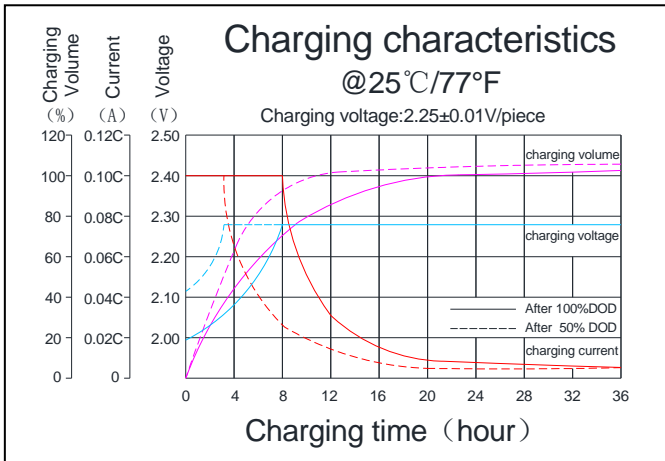

BATTERY CONSTRUCTION

Component	Positive plate	Negative plate	Container & Cover	Safety valve	Terminal	Separator	Electrolyte	Pillar seal
Features	Thick high Sn low Ca grid with special paste	Balanced Pb-Ca grid for improved recombination efficiency	ABS (UL94-V0 optional)	Flame Si-Rubbeand aging resistancer	Female Copper Insert M8(torque:7~9N.m	Advanced AGM separator for high pressure cell design	Dilute high purity sulphuric acid with fumed Silica gel	Two layers epoxy resin seal

MCA Battery Manufacture Co.,Ltd.

Cangjiang Industrial Estate Gaoming District Foshan City China
 Tel: +86-757-66752600 Fax: +86-757-66752601

Copyright©2018 MCA Battery Manufacture Co.,Ltd.